



**Operating Instructions
for
Digital Indicating Unit**

Model: DAG-A34



We don't accept warranty and liability claims neither upon this publication nor in case of improper treatment of the described products.

The document may contain technical inaccuracies and typographical errors. The content will be revised on a regular basis. These changes will be implemented in later versions. The described products can be improved and changed at any time without prior notice.

© **Copyright**

All rights reserved.

1. Contents

1. Contents.....	2
2. Note	3
3. Instrument Inspection.....	3
4. Regulation Use	3
5. Short Description.....	4
6. Assembly	5
7. Electrical Connection	6
8. Function, Description and Operation.....	7
9. Setting up the device.....	8
9.1 Switching on	8
9.2 Standard parameterization:.....	8
9.3 Programming interlock RUN	9
9.4 Extended parameterization	9
10. Reset to default values.....	11
11. Functional principle of the switching points	12
12. Technical Information.....	13
13. Order Codes	13
14. Dimensions	13
15. Safety advice	13
16. Error elimination	15
17. Disposal	16
18. EU Declaration of Conformance	17
19. UK Declaration of Conformity.....	18

Manufactured and Sold by:

Kobold Messring GmbH
Nordring 22-24
D-65719 Hofheim
Tel.: +49(0)6192-2990
Fax: +49(0)6192-23398
E-Mail: info.de@kobold.com
Internet: www.kobold.com

2. Note

Please read these operating instructions before unpacking and putting the unit into operation. Follow the instructions precisely as described herein.

The instruction manuals on our website www.kobold.com are always for currently manufactured version of our products. Due to technical changes, the instruction manuals available online may not always correspond to the product version you have purchased. If you need an instruction manual that corresponds to the purchased product version, you can request it from us free of charge by email (info.de@kobold.com) in PDF format, specifying the relevant invoice number and serial number. If you wish, the operating instructions can also be sent to you by post in paper form against an applicable postage fee.

Operating instructions, data sheet, approvals and further information via the QR code on the device or via www.kobold.com

The devices are only to be used, maintained and serviced by persons familiar with these operating instructions and in accordance with local regulations applying to Health & Safety and prevention of accidents.

When used in machines, the measuring unit should be used only when the machines fulfil the EC-machine guidelines.

3. Instrument Inspection

Instruments are inspected before shipping and sent out in perfect condition.

Should damage to a device be visible, we recommend a thorough inspection of the delivery packaging. In case of damage, please inform your parcel service / forwarding agent immediately, since they are responsible for damages during transit.

Scope of delivery:

The standard delivery includes:

- Digital Indicating Unit model: DAG-A34

4. Regulation Use

Any use of the device, which exceeds the manufacturer's specification, may invalidate its warranty. Therefore, any resulting damage is not the responsibility of the manufacturer. The user assumes all risk for such usage.

5. Short Description

The panel instrument **DAG-A34** is a 4-digit device for Pt100 sensors and a visual limit value monitoring via the display. The configuration happens via three front keys. An integrated programming interlock prevents unrequested changes of the parameter and can be unlocked again via an individual code.

The electrical connection happens on the rear side via plug-in terminals.

Selectable functions like e.g. the recall of the min/max-value, an impedance matching up to 20°C and a direct change of the limit value in operating mode complete the modern device concept.

6. Assembly

Please read the *Safety advice* on page 12 before installation and keep this user manual for future reference.

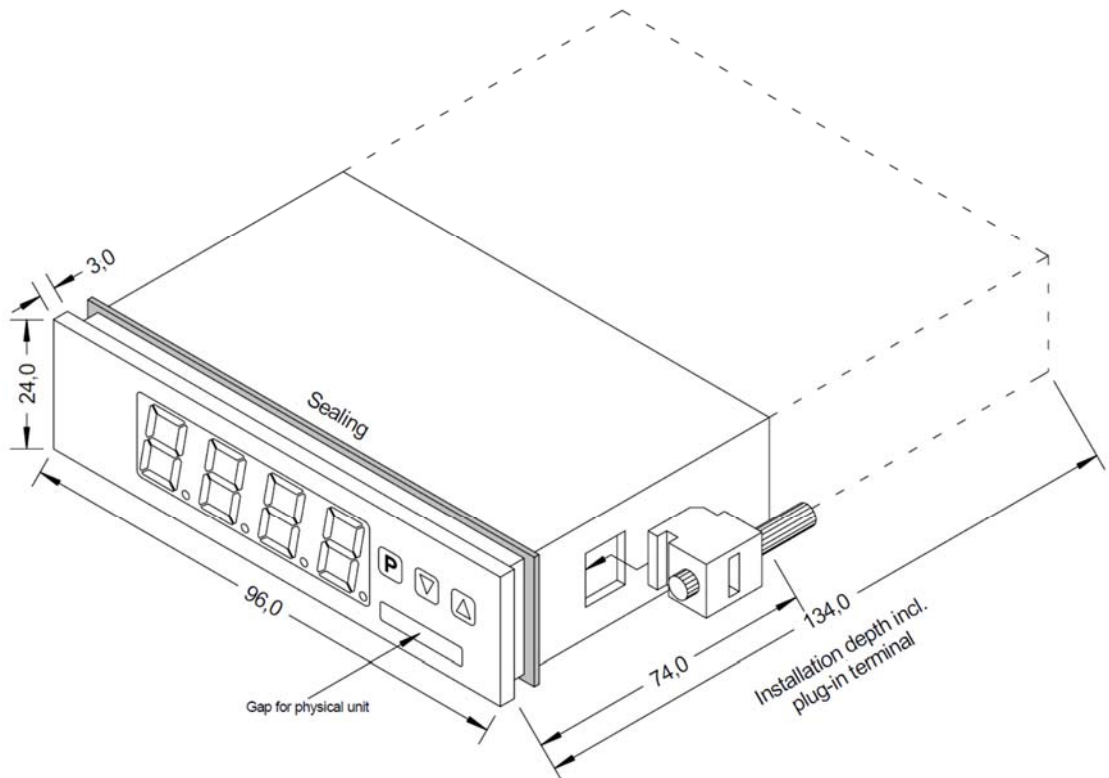

1. After removing the fixing elements, insert the device.
2. Check the seal to make sure it fits securely.
3. Click the fixing elements back into place and tighten the clamping screws by hand. Then use a screwdriver to tighten them another half a turn.

CAUTION! The torque should not exceed 0.1 Nm!

DAG-A34

7. Electrical Connection

DAG-A340 with supply of 230 VAC
DAG-A344 with supply of 115 VAC
DAG-A342 with supply of 24 VAC

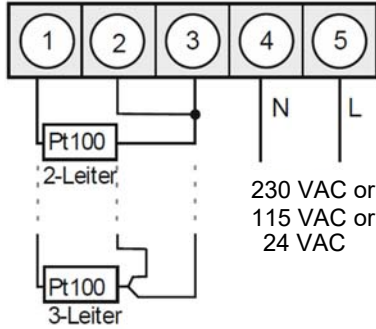

DAG-A343 with supply of 24 VDC

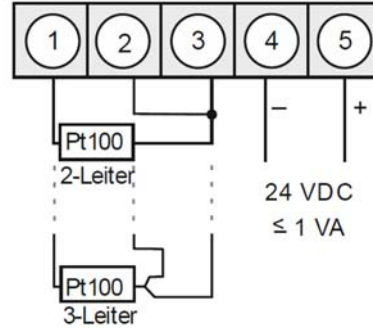

Advice:

The galvanic isolation in devices with temperature sensors, that **do not** have a galvanic connection to an extrinsic potential, can be cancelled by a bridge from terminal 3 to 4 and thus stabilise the device against external failures.

Devices with a supply of 230 VAC need to connect terminal 3 to signal ground

8. Function, Description and Operation

Operation

The operation is divided into two different levels.

Menu Level

Here it is possible to navigate between the individual menu items.

Parameterization level:

The parameters stored in the menu item can be parameterized here.

Functions that can be adjusted or changed are always indicated with a flashing of the display. Adjustments made at the parameterization level should be always confirmed by pressing the **[P]** key to save them.

However, the display automatically saves all adjustments and then switches to operation mode if no further keys are pressed within 10 seconds.

Level	Button	Description
Menu level	[P]	Change to parameterization level with the relevant parameters
	▼ ▲	For navigation at the menu level
Parameter level	[P]	To confirm the changes made at the parameterization level
	▼ ▲	To change the value or setting

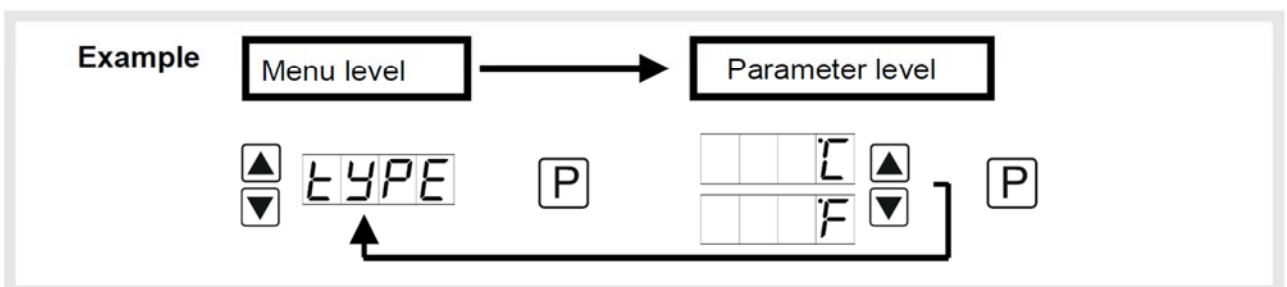

9. Setting up the device

9.1 Switching on







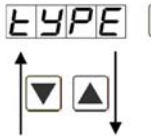

Once the installation is complete, you can start the device by applying the current loop. Check beforehand once again that all the electrical connections are correct.

Starting sequence

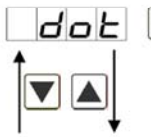
For 1 second during the switching-on process, the segment test (8 8 8 8 8) is displayed, followed by an indication of the software type and, after that, also for 1 second, the software version. After the start-up sequence, the device switches to operation/display mode.

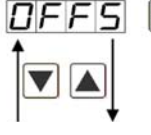
9.2 Standard parameterization:

To be able to parameterize the display, press the [P] key in operating mode for 1 second. The display then changes to the menu level with the first menu item **TYPE**.

Menu level	Parameterization level
	<p>Type of the temperature measurement, <i>TYPE</i>: Default: °C</p>  <p>For representing of temperature choose between °C and °F and confirm with [P]. The display then switches back to the menu level again.</p>
	<p>Setting the decimal place / sign of physical unit, <i>END</i>: Default: 000.0</p>  <p>The decimal place and the physical unit are set with [▼] [▲]. If e.g. the temperature measurement is chosen in °C, 0°C or 0.0°C can be selected on the parameterization level. Confirm with [P], the display then switches back to the menu level again.</p>
	<p>Impedance matching, <i>OFFS</i>: Default: 0.0</p>  <p>The value for the sensor alignment is adjusted from the smallest to the highest place with [▼] [▲] and confirmed digit per digit with [P]. After the last place the display switches back to the menu level. The value alignment for a temperature measurement in °C can be set between -20.0 and +20.0 and for a measurement in °F between -36.0 and +36.0. If the measurement is redirected later, the value is rounded.</p>
	<p>Setting the display time, <i>SEC</i>: Default: 01.0</p>  <p>The display time is set with [▲] [▼]. The display moves up in increments of 0.1 sec up to 1 second and in increments of 1.0 to 10.0 seconds. Confirm the selection by pressing the [P] button. The display then switches back to the menu level again.</p>





9.3 Programming interlock RUN

	<p>Activation / deactivation of the programming lock and completion of the standard parameterization, <i>RUN</i>: Default: <i>ULOC</i></p> <p style="text-align: center;"> </p> <p>With the aid of the [▲] [▼] keys, you can choose between the deactivated key lock <i>ULOC</i> (works setting) and the activated key lock <i>LOC</i>. Make the selection with [P]. After this, the display confirms the settings with "- - - -", and automatically switches to operating mode. If <i>LOC</i> was selected, the keyboard is locked. To get back into the menu level, you must press [P] for 3 seconds in operating mode. You must now enter the <i>CODE</i> (works setting 1 2 3 4) that appears using the [▲] [▼] keys plus [P] to unlock the keyboard. <i>FAIL</i> appears if the input is wrong.</p>
--	---

9.4 Extended parameterization

By pressing the [▲] & [▼] keys during standard parameterization for one second, the display switches to the extended parameterization mode. Operation is the same as in standard parameterization.

Menu level	Parameterization level
	<p>Min/max-value inquiry - Assignment of key functions, <i>TAST</i>: Default: <i>NO</i></p> <p style="text-align: center;"> </p> <p>Here, you can enter for the operating mode either a min/max-value inquiry or a threshold value correction on the arrow keys. If the min/max-memory is activated with <i>EHER</i>, the measured min/max-values will be saved during operation and can be called up via the arrow keys [▲] [▼]. The values are lost if the device is restarted. If the threshold value correction <i>LI.1</i> is selected, the limit values can be changed during operation without hindering the operating procedure. With <i>TARA</i> the display is tared to zero and is saved permanently as offset. The device confirms the correct taring by showing <i>0000</i> in the display. If <i>NO</i> is parameterized, the navigation keys [▼] [▲] have no function in operating mode.</p>
	<p>Flashing of display, <i>FLAS</i>: Default: <i>NO</i></p> <p style="text-align: center;"> </p> <p>Here, flashing of the display can be added as an extra alarm function, either to the first limit value (select: <i>LI-1</i>), the second limit value (select: <i>LI-2</i>) or to both limit values (select: <i>LI-12</i>). With <i>NO</i> (works setting), no flashing is assigned at all.</p>

Menu level	Parameterization level
	<p>Limit values / Limits, LI-1: Default: 0200</p> <p>LI-1 P 0 P 0 P 0 P 0 P</p> <p>For both limit values, two different values can be parameterized. With this, the parameters for each limit value are called up one after the other.</p>
	<p>Hysteresis for limit values, HY-1: Default: 0000</p> <p>HY-1 P 0 P 0 P 0 P 0 P</p> <p>For both limit values, a hysteresis function exists that reacts according to the functional principle (operating current / quiescent current).</p>
	<p>Function if display falls below / exceeds limit value, FU-1: Default: HIGH</p> <p>FU-1 P HIGH LOW P</p> <p>To indicate if the value falls below the lower limit value, <i>LOW</i> can be selected (LOW = lower limit value) and if it goes above the upper limit value, <i>HIGH</i> can be selected (HIGH = upper limit value). LOW corresponds to the quiescent current principle and HIGH to the operating current principle.</p>
	<p>Limit value /Limits, LI-2: Default: 0300</p> <p>LI-2 P 0 P 0 P 0 P 0 P</p> <p>For both limit values, two different values can be parameterized. With this, the parameters for each limit value are called up one after the other.</p>
	<p>Hysteresis for limit values, HY-2: Default: 0000</p> <p>HY-2 P 0 P 0 P 0 P 0 P</p> <p>For both limit values, a hysteresis function exists that reacts according to the functional principle (operating current / quiescent current).</p>

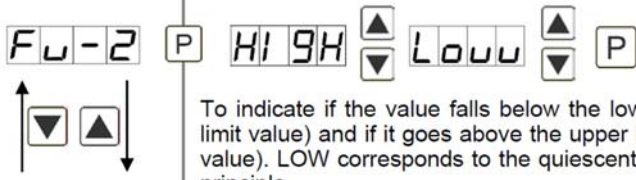
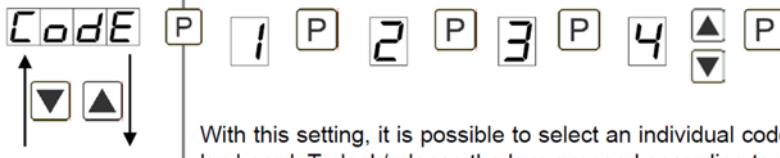
Menu level	Parameterization level
	<p>Function if display falls below / exceeds limit value, <i>FU-2</i>: Default: <i>HIGH</i></p>  <p>To indicate if the value falls below the lower limit value, <i>LOW</i> can be selected (LOW = lower limit value) and if it goes above the upper limit value, <i>HIGH</i> can be selected (HIGH = upper limit value). LOW corresponds to the quiescent current principle and HIGH to the operating current principle.</p>
	<p>Setting the code, <i>CODE</i>: Default: <i>1234</i></p>  <p>With this setting, it is possible to select an individual code (works setting 1 2 3 4) for locking the keyboard. To lock/release the key, proceed according to menu item <i>RUN</i>.</p>

10. Reset to default values

To return the unit to a **defined basic state**, a reset can be carried out to the default values. The following procedure should be used:

- Switch off the power supply
- Press button [P]
- Switch on voltage supply and press [P]-button until „- - -“ is shown in the display.

With reset, the default values of the program table are loaded and used for subsequent operation. This puts the unit back to the state in which it was supplied.

Caution! All application-related data are lost.

11. Functional principle of the switching points

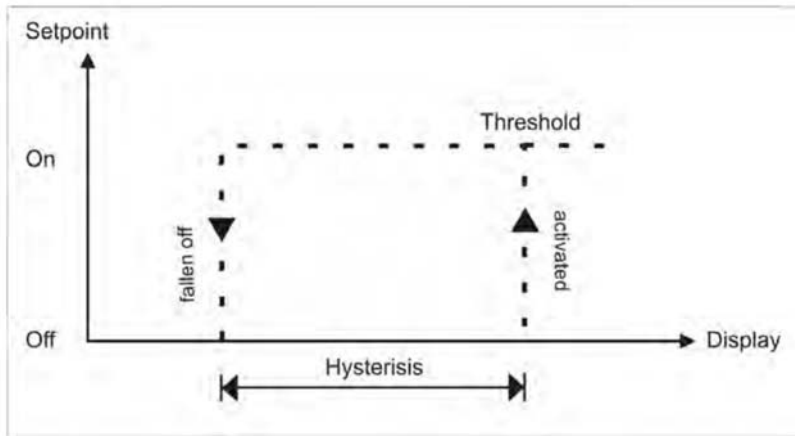

Limit value exceedance "HIGH"

The switching point S1-S2 is "off" below the threshold and "on" on reaching the threshold.

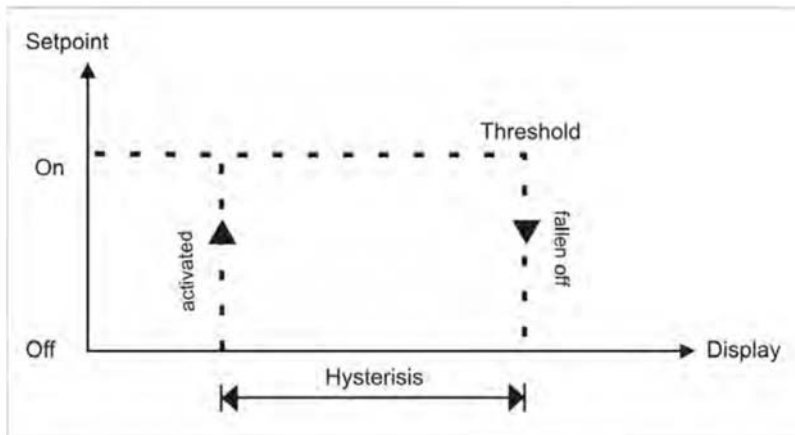

Limit value undercut "LOW"

The switching point S1-S2 is "on" below the threshold and switched "off" on reaching the threshold.

Alarms / optical switching point display

An activated set point can be optically indicated by flashing of the 7-segment display.

Functional principle of the alarms	
Alarm	Deactivated, display value
Threshold	Threshold/limit value for switch over
Hysteresis	Width of the window between the thresholds
Operating principle	Limit value exceedance / limit value undercut

12. Technical Information

Operating instructions, data sheet, approvals and further information via the QR code on the device or via www.kobold.com

13. Order Codes

Operating instructions, data sheet, approvals and further information via the QR code on the device or via www.kobold.com

14. Dimensions

Operating instructions, data sheet, approvals and further information via the QR code on the device or via www.kobold.com

15. Safety advice

Please read the following safety advice and the assembly *chapter 6* before installation and keep it for future reference.

Proper use

The **DAG-A34** is designed for the evaluation and display of Pt100 signals.



Danger! Careless use or improper operation can result in personal injury and/or damage to the equipment.

Control of the device

The panel meters are checked before dispatch and sent out in perfect condition. Should there be any visible damage, we recommend close examination of the packaging. Please inform the supplier immediately of any damage.



Installation

The **DAG-A34-device** must be installed by a suitably **qualified specialist** (e.g. with a qualification in industrial electronics).

Notes on installation

- There must be no magnetic or electric fields in the vicinity of the device, e.g. due to transformers, mobile phones or electrostatic discharge.
- The **fuse rating** of the supply voltage should not exceed a value of **6A N.B. fuse**.
- Do not install **inductive consumers** (relays, solenoid valves etc.) near the device and **suppress** any interference with the aid of RC spark extinguishing combinations or free-wheeling diodes.
- Keep input, output and supply lines separate from each other and do not lay them parallel with each other. Position “go” and “return lines” next to one another. Where possible use twisted pair. So, the best measuring results can be received.
- Screen off and twist sensor lines. Do not lay current-carrying lines in the vicinity. Connect the **screening on one side** on a suitable potential equaliser (normally signal ground).
- The device is not suitable for installation in areas where there is a risk of explosion.
- Any electrical connection deviating from the connection diagram can endanger human life and/or can destroy the equipment.
- The terminal area of the devices is part of the service. Here electrostatic discharge needs to be avoided. Attention! High voltages can cause dangerous body currents. Galvanic insulated potentials within one complex need to be placed on an appropriate point (normally earth or machines ground). So, a lower disturbance sensibility against impacted energy can be reached and dangerous potentials, that can occur on long lines or due to faulty wiring, can be avoided.

16. Error elimination

	Error description	Measures
1.	<p>The unit permanently indicates overflow.</p> 	<ul style="list-style-type: none"> • The input has a very high measurement, check the measuring circuit. • The input is open.
2.	<p>The unit permanently shows underflow.</p> 	<ul style="list-style-type: none"> • The input has a very low measurement, check the measuring circuit. • The input is open.
3.	<p>The word "HELP" lights up in the 7-segment display.</p>	<ul style="list-style-type: none"> • The unit has found an error in the configuration memory. Perform a reset on the default values and re-configure the unit according to your application.
4.	<p>Program numbers for parameterising of the input are not accessible.</p>	<ul style="list-style-type: none"> • Programming lock is activated • Enter correct code
5.	<p>"ERR1" lights up in the 7-segment display</p>	<ul style="list-style-type: none"> • Please contact the manufacturer if errors of this kind occur.
6.	<p>The device does not react as expected.</p>	<ul style="list-style-type: none"> • If you are not sure if the device has been parameterised before, then follow the steps as written in <i>chapter 10</i> and set it back to its delivery status.
7.	<p>The temperature value is unstable.</p>	<ul style="list-style-type: none"> • Please check the possibility to set aside the galvanic insulation for a discharging of failures as described under <i>chapter 7</i>, "Electrical connection". Before make sure that the possible metal sensor is separated from the sensor element.

17. Disposal

Note!

- Avoid environmental damage caused by media-contaminated parts
- Dispose of the device and packaging in an environmentally friendly manner
- Comply with applicable national and international disposal regulations and environmental regulations.

Batteries

Batteries containing pollutants are marked with a sign consisting of a crossed-out garbage can and the chemical symbol (Cd, Hg, Li or Pb) of the heavy metal that is decisive for the classification as containing pollutants:

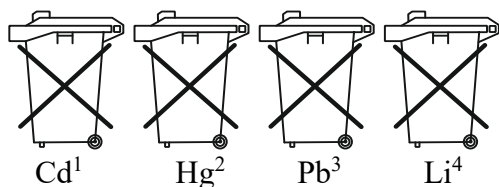

1. „Cd" stands for cadmium
2. „Hg" stands for mercury
3. „Pb" stands for lead
4. „Li" stands for lithium

Electrical and electronic equipment

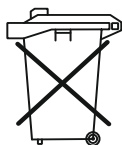

18. EU Declaration of Conformance

We, KOBOLD Messring GmbH, Nordring 22-24, 65719 Hofheim, Germany, declare under our sole responsibility that the product:

Digital Indicating Unit for Panel Mounting

Model: DAG-A34

to which this declaration relates is in conformity with the following EU directives stated below:

2014/30/EU	EMC Directive
2014/35/EU	Low Voltage Directive
2011/65/EU	RoHS (category 9)
2015/863/EU	Delegated Directive (RoHS III)

Also, the following standards are fulfilled:

EN 61010-1:2010+A1:2019+A1:2019/AC:2019

Safety requirements for electrical equipment for measurement, control and laboratory use - Part 1: General requirements

EN 61326-1:2013

Electrical equipment for measurement, control and laboratory use - EMC requirements - Part 1: General requirements

EN IEC 63000:2018 Technical documentation for the assessment of electrical and electronic products with respect to the restriction of hazardous substances

Hofheim, 08 Sept 2023



H. Volz
General Manager



J. Burke
Compliance Manager

19. UK Declaration of Conformity

We, KOBOLD Messring GmbH, Nordring 22-24, 65719 Hofheim, Germany, declare under our sole responsibility that the product:

Digital Indicating Unit for Panel Mounting

Model: DAG-A34

to which this declaration relates is in conformity with the following UK directives stated below:

S.I. 2016/1091	Electromagnetic Compatibility Regulations 2016
S.I. 2016/1101	Electrical Equipment (Safety) Regulations 2016
S.I. 2012/3032	The Restriction of the Use of Certain Hazardous Substances in Electrical and Electronic Equipment Regulations 2012

Also, the following standards are fulfilled:

BS EN 61010-1:2010+A1:2019

Safety requirements for electrical equipment for measurement, control, and laboratory use. General requirements

BS EN 61326-1:2013

Electrical equipment for measurement, control and laboratory use. EMC requirements. General requirements

BS EN IEC 63000:2018

Technical documentation for the assessment of electrical and electronic products with respect to the restriction of hazardous substances.

Hofheim, 08 Sept 2023



H. Volz
General Manager



J. Burke
Compliance Manager