



## Transmitter/Controller

for Conductivity, TDS, Resistance,  
Standard signals and Temperature



measuring  
•  
monitoring  
•  
analysing

### ACM-1 Compact-Line



- Measuring range  
Conductivity: 0 ... 200 mS/cm  
Temperature: Pt100/Pt1000: -50 ... +250 °C  
NTC/PTC: 0.1 ... 30 k $\Omega$   
Standard signal: 0(4) ... 20 mA, 0 - 10V  
Resistance: min. 100  $\Omega$ , max. 3 k $\Omega$
- Input (standard)  
1 x conductivity, Resistance or TDS and  
1 x temperature/resistance or standard signal and  
2 x binary inputs
- Output (standard)  
2 x relay (changeover contact)  
1 x power supply for 2-wire sensor 17V<sub>DC</sub>
- 3 breadboards (optional retrofit)
  - relay (changeover contact)
  - double relay (2 x NO, common pin)
  - 1 x analogue output 0(4) ... 20 mA 0(2) ... 10V
  - 1 x semiconductor relay TRIAC, 1 A
  - 2 x semiconductor switch (Photo-Mos)
  - supply voltage for sensor  $\pm 5 V_{DC}$
  - supply voltage for sensor + 12 V<sub>DC</sub>
  - interface RS 485
  - datalogger with RS 485 and real time clock
  - Profibus DP
- Freely programmable via keys or  
by optional software
- Programmable backlight graphic display  
(1, 2 or 3 display values, trend display,  
 bargraph, trend curve)
- Calibration routines, wash timer
- Math and logic module
- 13 operator languages integrated



A1

KOBOLD companies worldwide:

ARGENTINA, AUSTRALIA, AUSTRIA, BELGIUM, BULGARIA, CANADA, CHILE, CHINA, COLOMBIA,  
CZECHIA, EGYPT, FRANCE, GERMANY, GREAT BRITAIN, HUNGARY, INDIA, INDONESIA, ITALY,  
MALAYSIA, MEXICO, NETHERLANDS, PERU, POLAND, REPUBLIC OF KOREA, ROMANIA,  
SINGAPORE, SPAIN, SWITZERLAND, TAIWAN, THAILAND, TUNISIA, TURKEY, USA, VIETNAM

KOBOLD Messring GmbH  
Nordring 22-24  
D-65719 Hofheim/Ts.  
Head Office:  
+49(0)6192 299-0  
+49(0)6192 23398  
info.de@kobold.com  
www.kobold.com



**Description**

The compact transmitter /controller ACM-1.. measures the conductivity value, TDS value or specific resistance. It is available as panel-mounted device according to DIN/EN 61554 or as field housing.

Measured values and parameters are displayed on a high-contrast graphic display in plain text.

Easy configuration via buttons or PC with optional software provide a simple and user friendly operation.

An integrated math and logic module enables the integration of the measured values in mathematical formulas so that the measured variables can be displayed.

The transmitter has two analogue and two binary inputs.

- Analogue input:  
For conductivity, TDS or resistance sensor  
Conventional 2-electrode conductivity cells can be connected.
- Compensation input:  
For connection of a  
resistance thermometer Pt 100/Pt1000/NTC/PTC,  
a standard signal (0(4) ... 20 mA, 0(2) ... 10 V) or  
resistance transmitter (min 100 Ω, max. 3 kΩ)
- 2 binary inputs  
As initiators for actions (keyboard inhibit, Hold,  
Alarm suppression, reset partial or total quantity,  
parameter set changeover) or connecting a pulse  
encoder e. g. for flow measurement (instantaneous value,  
partial quantity, total quantity)

The two control relays can be used as limit value or two position, three position, three position controller or continuous controller with P-, PI-, PD- or PID action.

The modular units can be retrofitted with 3 plug-in boards and so be upgraded flexibly for different measuring and control tasks

The followings boards are available:

- input standard signal 0(4) ... 20 mA, 0(2) ... 10V
- supply for ISFET sensor 5V
- supply for e. g. proximity switch
- analogue output 0(4) ... 20 mA, 0(2) ... 10 V
- 1 relay (changeover contact)
- 2 relay (NO with common pin)
- semiconductor relay TRIAC 1A
- semiconductor switch Photo-Mos
- interface RS 485 (max. 1)
- interface Profibus DP (max. 1)
- datalogger (max. 1)

**A complete measuring device comprises:**

- the conductivity transmitter model ACM-1
- a conductivity measuring cell model ACS-Z with integrated temperature sensor
- a suitable measuring cable model ACK-Z

**Application examples for conductivity measurements**  
(Only with selection of appropriate measuring cells)

**Low conductivity (to 500 µS/cm)**

- Monitoring the boiler feed water
- Monitoring and assessing ion exchanger
- Monitoring the reverse osmosis
- Monitoring the cooling waters
- Inspection of sea water desalination

**Average conductivity (to 10 mS/cm)**

- Inspection of drinking water treatment
- Desalting of cooling water
- Waste water inspection in clarification plants

**High conductivity (to 600 mS/cm)**

- Quality control for drinks (for example milk, beer)
- Monitoring bottle cleaning plants
- Control of concentration of acids and lyes (for example CIP cleaning, electroplating plants)
- Detection of phase boundaries (product/water separation)

**Cell constant and measurement range for 2-electrode conductivity cells**

Cell constant (K)	Recommended/practical measurement scope (depending on the conductivity cell)
0.01 1/cm	0.05 µS/cm ... 20 µS/cm
0.1 1/cm	1 µS/cm ... 1000 µS/cm
1.0 1/cm	0.01 mS/cm ... 100 mS/cm
3.0 1/cm	0.1 mS/cm ... 30 mS/cm
10.0 1/cm	0.1 mS/cm ... 200 mS/cm

**Example:** To conduct a measurement in the range from 10 µS/cm ... 500 µS/cm select a conductivity cell with a cell constant K = 0,1 1/cm. Configure the unit µS/cm on the instrument without places after the decimal.

**Functional description**

The parameters of the units can be easily configured via keyboard or optional software via PC. The operation is protected by a password. Up to 8 user data that must be changed frequently, can be unblocked in one user file.

**Display**

The display is a graphic display in plain text. Different displays can be configured by customer. Large display, double display, bargraph, trend curve with various status indicators and alarms.

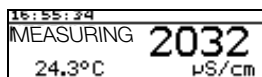

Normal display

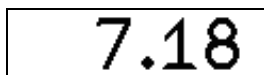

Large display

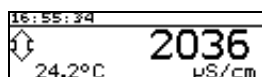

Trend display

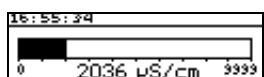

Bargraph



Trend curve (Data monitor)

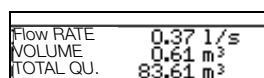

Flow

### Calibration

For units with additional plug-in boards the following calibration are possible:

Zero point, end value, zero point and end value, cell constant, temperature coefficient.

### Linear scaling

With function "linear scaling" the input signal can be displayed linearly. The following units are available:  $\mu\text{S}/\text{cm}$ ,  $\text{mS}/\text{cm}$ , %,  $\text{mV}$ ,  $\text{pH}$ ,  $\text{ppm}$ , customized up to 5 characters.

### Customized with table

Nonlinear relationships between input and output size can be processed. E. g. Content of horizontal cylinders in level measurement. The values can be stored in a table via software.

### Calibration

1, 2 or 3-point calibration for  $\text{pH}$  and 1-point calibration for redox (for display  $\text{mV}$ ) respectively 2-point calibration for redox (%-display, free scaling).

The last 5 successful calibrations can be stored in a log-book.

### Wash timer

Cyclically recurring actions can be triggered by activation a relay.

### Technical Data

#### General

Housing:	Plastic, for panel mounting according to DIN IEC 61554 or aluminum field housing, orange
Ambient temperature:	-5 ... +55 °C (panel mounting) -5 ... +50 °C (field housing)
Storage temperature:	-30 ... +70 °C
Climatic rating:	rel. humidity $\leq 90\%$ annual mean, no condensation
Mounting position:	horizontal
Weight:	Installation housing: approx. 380 g (fully fitted with 3 option boards) Field housing: approx. 1780 g
Protection:	Installation housing: IP 65 (front), IP 20 (rear)

Field housing:	IP 65
Display:	LC graphic display, 122 x 32 Pixel blue with backlight
Power supply:	110 ... 240 $V_{AC}$ , -15/+10%, 48 ... 63 Hz (standard) 20 ... 30 $V_{AC/DC}$ , 48 ... 63 Hz (special)
Power consumption :	max. 13 VA
Data backup:	EEPROM
Electrican connection:	screw terminals (rear) max. cable cross-section 2.5 $\text{mm}^2$
Menu languages:	German (factory set), English, French, Spanish, Dutch, Russian, Hungarian, Italian, Czech, Swedish, Portuguese, Polish, Rumanian

### Input 1 (standard)

#### Conductivity value

Measuring and control range:	0 ... 200 $\text{mS}/\text{cm}$ (depending on cell constan)
Temperature compensation range:	-10 ... +160 °C (note values of the sensor)
Accuracy:	$\leq 0.6\%$ of measuring range +0,3 $\mu\text{S}$ x cell constant (K)
Ambient temperature effect:	0.2% / 10 K

### Input 2 (standard)

(Temperature, standard signal or resistance)

#### Temperature Pt100/Pt1000

Measuring and control range:	-50 ... +250 °C (switchable to °F)
Accuracy:	$\leq 0.25\%$ of measuring range
Ambient temperature effect:	0.2% / 10 K

#### Temperature NTC/PTC

Measuring and control range:	0.1 ... 30 $\text{k}\Omega$ (entry via table with 20 value pairs)
Accuracy:	$\leq 1.5\%$ of measuring range
Ambient temperature effect:	0.2% / 10 K

#### Standard signal

Measuring and control range:	0(4) ... 20 mA or 0 ... 10 V
Accuracy:	0.25% of measuring range
Ambient temperature effect:	0.2% / 10 K

#### Resistance transmitter

Measuring and control range:	minimal: 100 $\Omega$ , maximal 3 $\text{k}\Omega$
Accuracy:	$\pm 5\Omega$
Ambient temperature effect:	0.1% / 10 K



## Technical Data (suite)

### Binary inputs (standard)

Activation:	Floating contact is open: function is not active Floating contact is closed: function is active
Function:	Key lock, manual mode, HOLD, HOLD inverse, alarm suppression, freeze measured value, level lock, reset partial quantity, reset partial quantity, parameter set changeover

### Outputs (standard)

#### 2 relay (changeover contact)

Contact rating:	5 A at 240 V <sub>AC</sub> resistive load
Contact service life:	350 000 operations at nominal load 750 000 operations at 1 A

### Sensor supply for 2-wire transmitter

17 V<sub>DC</sub> at 20 mA, open-circuit voltage approx. 25 V<sub>DC</sub>

### Controller (standard)

(see manual for configuration examples)

Controller type:	Limit comparators, limit controllers, pulse length controllers, pulse frequency, controllers, modulating controllers, continuous controllers
------------------	--

Controller structure: P / PI / PD / PID

### Optional boards

To extend functionality the units can be retrofitted with up to 3 optional boards.

### Inputs (optional max. 3)

#### Optional board standard signal

Measuring range:	0(2) ... 10 V, 0 ... 1 V (input resistance R <sub>E</sub> > 100 kΩ) 0(4) ... 20 mA (Voltage drop ≤ 1.5 V) resistance sensor, min. 100 Ω, max. 4 kΩ
------------------	---

Measuring accuracy: ≤ 0.05 % (resistance ± 4 Ω)

Ambient

temperature effect: 100 ppm/K

### Power supply external sensors (optional max. 3)

#### Optional boards supply ISFET

Output voltage: ± 5 V<sub>DC</sub>, 5 mA

#### Optional boards supply proximity switch

Output voltage: 12 V<sub>DC</sub>, 10 mA

### Outputs (optional max. 3)

#### Optional board 1 relay

Switching function:	changeover contact
Contact rating:	8 A at 240 V <sub>AC</sub> resistive load
Contact service life:	100 000 operations at nominal load 350 000 operations at 3 A

#### Optional board double relay

Switching function:	NO with common pin
Contact rating:	3 A bei 240 V <sub>AC</sub> resistive load
Contact service life:	350 000 operations at nominal load 900 000 operations at 1 A

#### Optional board semiconductor relay TRIAC

Contact rating:	1 A at 240 V <sub>AC</sub>
Protective circuit:	Varistor

#### Optional board 2 semiconductor relay Photo-MOS

Contact rating:	U ≤ 50 V <sub>AC/DC</sub>
Protective circuit:	I ≤ 200 mA

#### Optional board analogue output

Measuring range:	0(2) ... 10 V, 0 (4) ... 20 mA
Load resistance:	R <sub>load</sub> ≤ 500 Ω
Accuracy:	≤ 0,5 %

### Interfaces / data logger (optional max. 1)

#### Optional board RS 422/ 485

Protocol:	Modbus, Modbus Integer
Baud rate:	9600, 19200, 38400
Device address:	0 ... 255
Max. number of participants:	32

#### Optional board Profibus DP

Device address: 0 ... 255

#### Optional board RS 485 with data logger

The readout of data is only possible with the PC setup software! Further processing is possible with "Office" products.

Data sets:	up to 43 500 data sets (rings buffer)
Readout:	depending on the resolution 10 hours up to 150 days



Order Details (Example: ACM-1 E 1 0 0 0 Y)

Model	Version	Housing	Power supply	Option 1 (Optional board)	Option 2 (Optional board)	Option 3 (Optional board)	Special
ACM Evaluation electronics conductivity/specific resistance/TDS	1 = Compact-Line (new) Input: 1x conductivity/specific resistance/TDS 1x temperature/standard signal, 2x binary input sensor supply: 2-wire transmitter, 2 relays	E = for panel mounting F = Field housing S = Field housing with wall mounting bracket R = Field housing with pipe mounting bracket	1 = 110...240 V <sub>AC</sub> -15%/+10%, 48...63 Hz 2 = 20...30 V <sub>AC/DC</sub> , 48...63 Hz	4 = analogue output 0(4)-20 mA, 0(2)-10 V <b>(Standard)</b> 0 = without 1 = universal input (Pt100, Pt1000, resistance, current, voltage) 2 = 1 relay (changeover contact) 3 = 2 relays (NO with common pin) 4 = analogue output 0(4)-20 mA, 0(2)-10 V 5 = 2 Photo-Mos relay switch (0.2 A) 6 = 1 semiconductor relay TRIAC (1 A) 7 = 1 power supply 4.85 V (e. g. for ISFET sensor) 8 = 1 power supply 12 V <sub>DC</sub> (e. g. for inductive proximity switch)	0 = without 1 = universal input (Pt100, Pt1000, resistance, current, voltage) 2 = 1 relay (changeover contact) 4 = analogue output 0(4)-20 mA, 0(2)-10 V 5 = 2 Photo-Mos relay switch (0.2 A) 6 = 1 semiconductor relay TRIAC (1 A) 7 = 1 power supply 4.85 V (e. g. for ISFET sensor) 8 = 1 power supply 12 V <sub>DC</sub> (e. g. for inductive proximity switch)	0 = without 1 = universal input (Pt100, Pt1000, resistance, current, voltage) 2 = 1 relay (changeover contact) 3 = 2 Relais (NO with common pin) 4 = analogue output 0(4)-20 mA, 0(2)-10 V 5 = 2 Photo-Mos relay switch (0.2 A) 6 = 1 semiconductor relay TRIAC (1 A) 7 = 1 power supply 4.85 V (e. g. for ISFET sensor) 8 = 1 power supply 12 V <sub>DC</sub> (e. g. for inductive proximity switch) S = Interface RS 422/485 D = Data logger with interface RS 485 <sup>1)</sup> P = Interface Profibus DP	0 = without (factory set) Y = adjusted according to customer specification

<sup>1)</sup> The readout of data is only possible with the PC setup software! Note: All languages are available on the device side and can be changes by the customer at any time. The factory default setting of a language (except for "German") entail additional costs.

Accessories for transmitter APM-1 and ACM-1

Version	Code
Setup-Software	ACM-Soft
PC-Interface with transducer USB/TTL with adapter (pins/connector)	ACM-Int
Mounting bracket for top hat rail, front size (96 x 48 mm)	ACM-Halt

Electrical connection

(For details see manual or configuration sheet)

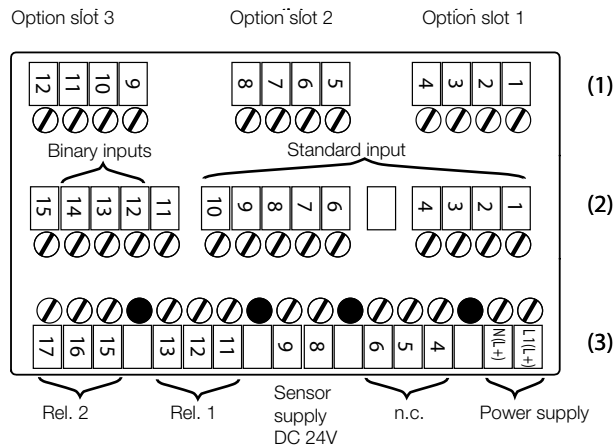



### Dimensions

#### Panel Mounting

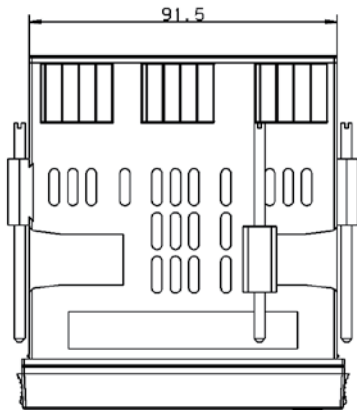
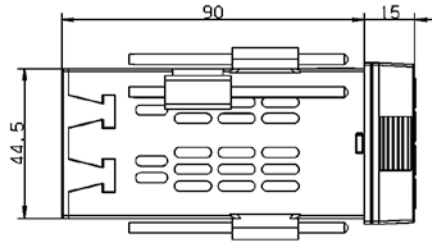
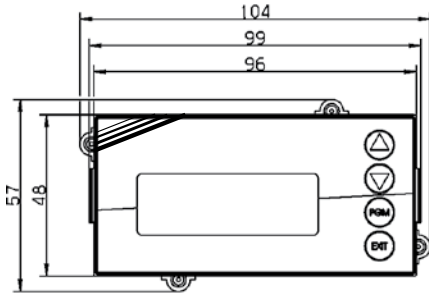

#### Panel cut-out

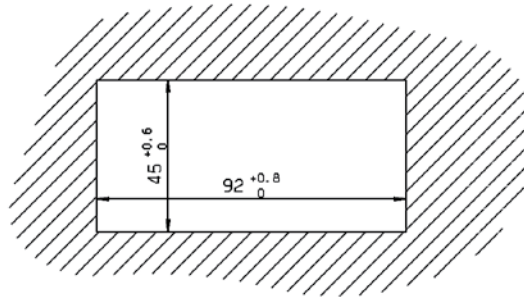

#### Field Housing

