



Filters and Mounting Supports for Humidity and Temperature Sensors and Hygrostats



measuring
•
monitoring
•
analysing

AFZ



- Mounting accessories
- Filters for sensors
Ø 12 mm, Ø 15 mm,
Ø 20 mm

A2



KOBOLD companies worldwide:

AUSTRALIA, AUSTRIA, BELGIUM, BULGARIA, CANADA, CHINA, CZECHIA, FRANCE, GERMANY, GREAT BRITAIN, HUNGARY, INDIA, INDONESIA, ITALY, MALAYSIA, MEXICO, NETHERLANDS, PERU, POLAND, REPUBLIC OF KOREA, RUSSIA, SPAIN, SWITZERLAND, THAILAND, TUNISIA, TURKEY, USA, VIETNAM

KOBOLD Messring GmbH
Nordring 22-24
D-65719 Hofheim/Ts.
Head Office:
+49(0)6192 299-0
+49(0)6192 23398
info.de@kobold.com
www.kobold.com

Description

The products on this info sheet are used for adapting sensors to the different places of application.

Filters protect the sensor against mechanical damage resulting from particle bombardment at relatively high air speeds and damaging deposits. The filters also keep harmful gases from the sensor. Deposits of oil and grease on the filter lead to corrupted measurements which can be rectified by changing the filter.

User instructions

Filters, and in particular sintered filters, change the dynamic behaviour of the sensors. Wet filters yield corrupted measurements until they have dried out fully.

To avoid corrosion we recommend to treat the threads of filters AFZ-GE20 ... AFZ-GE22 slightly with acid-free grease.



Dimensions [mm]

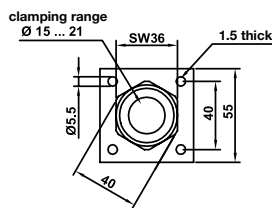
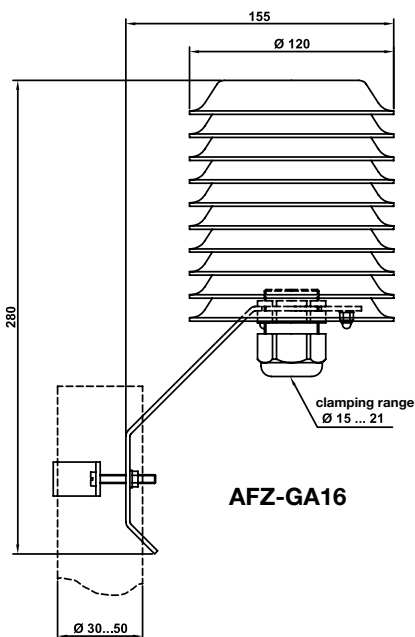

AFZ-GA20

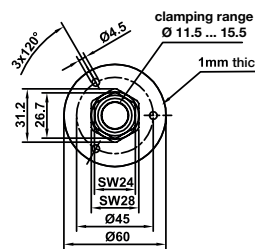

AFZ-GA24

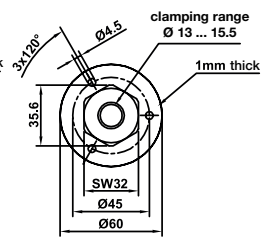



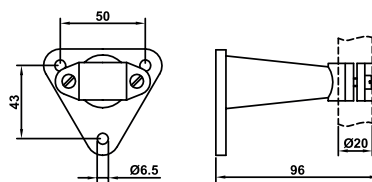



**AFZ-GA25
AFZ-GA48**









Console for wall mounting AFZ-GA50



Order Details Filter (for all sensor tubes Ø 15 mm)

Model	Code	Description	Response time Humidity at v = 1.5 m/s	Image
AFZ-G	E13	Coarse-pored sintered filter made of high-grade steel 1.4404 (max. pore size 100 µm). Protects the sensor element against high air speeds and dusty conditions. v up to approx. 20m/s. Ø 15 x 33, M 14x1, Operating temperature range: -80...200°C, IP65	< 1.5 min	
	E04	Filter made of high-grade steel 1.4301, side openings, front open. Protection against mechanical impacts. Suitable for low air speed and clean atmosphere. Ø 15 x 39, M 14x1, Operating temperature range: -80...200°C, IP10	20 s	
	E15	Filter made of high-grade steel 1.4301 with inserted filter gauze made of high-grade steel, mesh size approx. 0.11 mm. Protection against mechanical impacts and coarse dirt. Suitable for low air speed and clean atmosphere. Ø 15 x 39, M 14x1, Operating temperature range: -80...200°C, IP40	< 1 min	
	E26	Filter made of high-grade steel 1.4301 with inserted filter gauze and membrane (nominal pore size 0.45 µm). Protects against aerosols and dust. v up to approx. 10m/s, Ø 15 x 39, M 14x1, Operating temperature range: -50...150°C (max. 1h 200°C), IP54	< 2 min	
	E28	High-grade steel filter with mounted E18 (filter made of sintered PTFE), average pore size approx. 20 µm, for sensor tubes Ø 15mm. For use in extreme conditions. Ø 20 x 37, M 14x1, Operating temperature range: -50...200°C, IP65	< 3 min	
	E29	Sintered filter made of fine-pored PTFE, average pore size approx. 20 µm. For use in particularly demanding conditions. Meets the EMC directive for the AFK-A/AFK-F series, but not for the other sensors. Ø 15 x 39, M 14x1, Operating temperature range: -80...200°C, IP65	< 3 min	
	E94	PTFE filter and E04 stainless steel filter, open. Operating temperature range: -80...200°C		-







Order Details Filter (for all sensor tubes Ø 20 mm)

Model	Code	Description	Response time Humidity at v = 1.5 m/s	Bild
AFZ-G	E16	Protective basket of PBT plastic, side openings, metallized finish. Protection against mechanical impacts, suitable for low air speed and clean, non-aggressive atmosphere. Ø 20 x 25, M 18x1, Operating temperature range: -40...85°C IP20	< 20 s	
	E17	Same as type E16, but with inserted filter gauze made of high-grade steel, mesh size approx. 0.11 mm. Protection against mechanical impacts and coarse dirt. Suitable for low air speed and clean, non-aggressive atmosphere. Ø 20 x 25, M 18x1, Operating temperature range: -40...85°C IP40	< 1 min	
	E18	Sintered filter made of fine-pored PTFE for use in extreme conditions, average pore size 20 µm. Meets the EMC directive for the I Series; but not for the other sensors. Ø 20 x 25, M 18x1, Operating temperature range: -80...200°C IP65	< 3 min	
	E20	PBT plastic filter, metallized, with inserted filter gauze (nominal pore size 0.45 µm), v up to approx. 10m/s. Protects against aerosols. Ø 20 x 25, M 18x1, Operating temperature range: -40...85°C IP54	< 1.5 min	
	E21	Fine-pored sintered filter made of high-grade steel 1.4404, v up to approx. 20m/s. Protects the sensor element against high air speeds and dusty conditions. Ø 20 x 25, M 18x1, Operating temperature range: -50...150°C IP65	< 1.5 min	
	E22	Same as type E21, but coarse-pored (max. pore size 100 µm) and dynamically faster, v up to approx. 20m/s. Ø 20 x 25, M 18x1, Operating temperature range: -50...150°C IP65	< 1.5 min	
	E9G	PTFE filter and protective plastic basket E16, open, conductive metallized finish, suitable for low air speed and clean, non-aggressive atmosphere. Operating temperature range: -40...80°C		-
	E97	PTFE filter and E17 light, plastic. PTFE filter for humidity sensing element and protective basket, non-metallised		-







Order Details Filter for all sensors Ø 12 mm

Model	Code	Description	Response time Humidity at v = 1.5 m/s	Image
AFZ-G	E05	Sintered filter made of fine-pored PTFE with seal ring, IP65 - spare part	< 3 min	
	E07	Protective basket made of PC plastic, signal white, side openings, suitable for low air speed and clean atmosphere. Ø 12 x 33, M 10x0.75, operating temperature range: -40 ... 85 °C, IP20	< 20 s	
	E08	Protective plastic basket with internal membrane - spare part	< 1.5 min	

Order Details Accessories for Humidity and Temperature Sensors and Hygrostats

Model	Code	Description	Image
AFZ-G	A50	Wall console, plastic, for mounting sensors Ø 20 mm, with mounting sleeve A57 suitable for sensor tubes Ø 15 mm	
	A51	Fixing flange (oval) for duct mounting of AFH-G and AFS-G1, optional mounting device for easier sensor removal	
	A52	Fixing flange for AFB for sensors Ø 12 mm, with rubber sealing	
	A53	Protective tube, plastic for sensor types AFH-G and AFS-G1, recommended for protection against rain and sun in case of outdoor applications	
	A54	Protective tube made of gauze, recommended for air speeds between 8 and 15 m/s	
	A55	PTFE filter, two-part, for sensor types AFH-G and AFS-G1, recommended for extreme operating conditions	
	A56	Ventilated sensor tube with ventilating fan 24 V _{DC} for sensor types AFH-G und AFS-G1, for improved air flow	
	A57	Mounting sleeve for cable versions Ø 15 mm	-

Order Details Mounting Accessories

Model	Code	Description	Image
AFZ-G	A20	Mounting plate, suitable for mounting sensors Ø 20 mm in ventilation ducts up to 80 °C	
	A24	Mounting plate, suitable for mounting sensors Ø 15 mm in ventilation ducts up to 200 °C (stainless steel base plate with brass fitting)	
	A48	The same properties as AFZ-GA24, but suitable for sensors Ø 15 mm and Ø 20 mm	
	A25	Mounting plate, suitable for mounting sensors Ø 15 mm in ventilation ducts up to 100 °C, preferably for use in gases containing ammonia. (stainless steel base plate with stainless steel fitting)	
	A27	Pressure-tight feed-through fitting, thread G ½ x 12, brass, for sensors Ø 15 mm, pressure-tight up to 6 bar, suitable for temperatures up to 180 °C	
	A28	Pressure-tight feed-through fitting, thread G ¾ with locking ring, stainless steel, for sensors Ø 15 mm, pressure-tight up to 10 bar, suitable for temperatures up to 150 °C	
	A16	Weather guard for cable versions Ø 20 mm, recommended for protection against rain and sun in case of outdoor applications, with mounting sleeve A57 suitable for sensor tubes Ø 15 mm	