



Plug-On Display for Transmitters Option: Limit Contact, Ex-Version



measuring
•
monitoring
•
analysing

IECE_x

Ex

FLOW

LEVEL

PRESSURE

TEMPERATURE

AUF

- Universal mounting on transducers with 4-20 mA output plug EN 175 301-803 form A (old: DIN 43650)
- No additional power supply required
- Easy to programming using push buttons
- Compact sandwich construction
- Good readability through LED-display
- Option: Open-Collector-Output
ATEX: II 2G EEx ib IIC T4 Gb
IECE_x: ib IIC T4 Gb

KOBOLD companies worldwide:

AUSTRALIA, AUSTRIA, BELGIUM, BULGARIA, CANADA, CHINA, CZECHIA, EGYPT, FRANCE, GERMANY, GREAT BRITAIN, HUNGARY, INDIA, INDONESIA, ITALY, MALAYSIA, MEXICO, NETHERLANDS, PERU, POLAND, REPUBLIC OF KOREA, ROMANIA, RUSSIA, SPAIN, SWITZERLAND, THAILAND, TUNISIA, TURKEY, USA, VIETNAM

KOBOLD Messring GmbH
Nordring 22-24
D-65719 Hofheim/Ts.
Head Office:
+49(0)6192 299-0
+49(0)6192 23398
info.de@kobold.com
www.kobold.com

Description

The model AUF-... plug-on display is a universal local display suitable for use with various transmitters. The transmitter must be fitted with an analogue output and a connector in accordance with EN 175 301-803 form A. Model AUF-2000 can be delivered for use in hazardous areas.

The plug-on display is simply plugged in between connector and socket; it is then ready for operation. The plug-on display is user programmable. Scaling, the position of the decimal point, gate time and switch point (optional) may be set with two keys. The menu steps are output to the LED display field.

The plug-on display is supplied by the current loop of the 4-20 mA signal transmitter. No additional auxiliary power is required. The programmed parameters are stored in an EEPROM; they are therefore not lost after power failure. Over or under range are displayed as a message on the LED display.

All device functions are continuously monitored by an integral diagnostic system. The indicating unit can be rotated in 90° steps; it can thus be adapted to different installation positions. The integral open-collector output, available as an option, allows a transmitter to be retrofitted easily with a limit contact.

Order Details

Model	Description
AUF-1000	Standard plug-on display, 4-20 mA, 2-wire
AUF-1001	Plug-on display with Open Collector, 4-20 mA, 2-wire
AUF-2000	Plug-on display  II 2G EEx ib IIC T4 Gb, 4-20 mA, 2-wire
AUF-3000	Plug-on display, 4-20 mA, 3-wire
AUF-4000	Plug-on display, Input: pulse, output 4-20 mA (can only be calibrated with factory-mounted sensor)

Scope of supply

Plug-on display, silicone flat gasket ring, fixing screw, operating instruction, stickers with physical units

Technical Details

Display:	4-stellige, digit red LED display, digit height: 7.62 mm programmable decimal point setting
Indicating range:	-1999...9999
Accuracy:	0.2% of span ±1 digit
Electrical connection:	to transmitters with 4-20 mA output and plug acc. EN 175 301-803 form A (old: DIN 43 650), polarised
Sensor supply:	not required, loop-powered 24 V _{DC} ±20% (only AUF-4000)
Voltage drop:	≤5 V (acc. to max. load 250 Ω)
Conversion rate:	3 measurements/second
Gate time:	0,3 - 20 s (adjustable)





Data back-up:	non-volatile EEPROM
Error message:	HI: overrange LO: underflow
Programming:	with two keys, menu-assisted, scaling of indication, decimal point, gate time, error message switch point (AUF-1001)
Protection:	IP 65
Temperature influence on display:	0,1% / 10 K
Storage temperature:	-30 ... +80 °C

Technical Details AUF-1.../AUF-3...

Max. current load:	máx. 60 mA
Case material:	plastic PA6 GF30, orange window: PMMA red
Ambient temperature:	0 ... +60 °C
Open Collector:	model AUF-1001, PNP, máx. current load 90 mA

Technical Details AUF-2000

Conformance:	BVS 17 ATEX E 022 IECEX BVS 17.0012
ATEX-approval:	 II 2G Ex ib IIC T4 Gb
IECEX-approval:	 ib IIC T4 Gb
Voltage:	U _i 28 V _{DC}
Current:	I _i 100 mA
Power:	P _i 0,9 W
Effective inner capacitance C _i :	negligible
Effective inner inductance L _i :	negligible
Housing material:	polyamide compound, black window: PMMA, red
Ambient temperature	-20 ... +40 °C

Technical Details AUF-4000

(option for DIN plug connector connection, can only be calibrated with factory-mounted sensor)	
Display:	4-segment red LED
Temperature range:	-20 to +80 °C
Power supply:	24 V _{DC} ±20%
Input:	pulses of DTK (NPN-Hall effect sensor)
Output:	4-20 mA, 3-wire
Load:	250 Ω
Option:	presetting according to customer specifications

Application Examples

Flow



- Calorimetric flowmeter
- Turbine flowmeter with analogue output
- Vortex flowmeter

Pressure



- Pressure sensors
- Manometer with analogue output

Level



- Level transmitter
- Bypass level indicator with transmitter

Temperature



- Temperature sensors with head mounted transmitter

Adjustment

For adjustment, the 4 screws (1) of the display should be unscrewed and the cover removed.

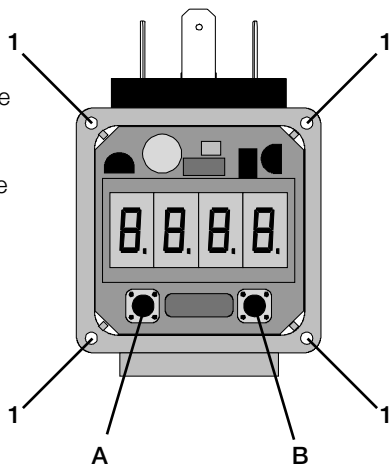

- Simple programming through keys A and B
- Free scaling of display value
- Software oriented adjustment of the decimal point
- Adjustable gate time of the display
- Recognition of overranging
- Freely programmable set-point adjustment (option)

Dimensions

Front view

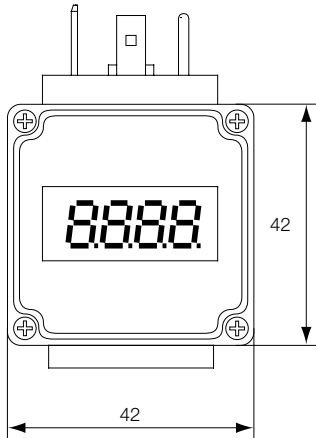

Side view

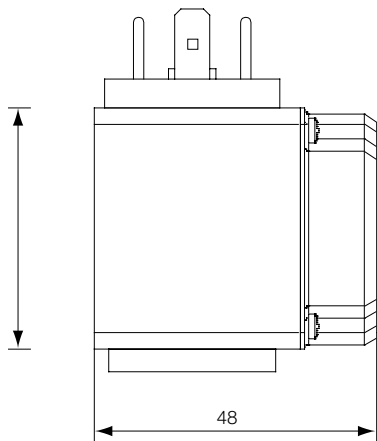

Accessory

For mounting of the plug-on display on devices with PG-connection, different adapters are available. The adapter is simply screwed in the existing PG-cable gland and wired to the device. At the opposite side of the adapter, is a plug according to DN 43650, on which the sandwich display can be simply plugged on.

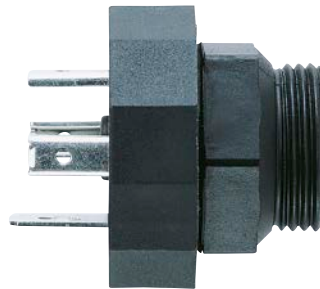

Ordering Details

Order no.	Description
AUF-PG11	for fitting in a PG-11 cable gland
AUF-PG13	for fitting in a PG-13.5 cable gland
AUF-PG16	for fitting in a PG-16 cable gland
AUF-ZM20	for fitting in a M20x1.5 cable gland

Further options for OEM applications

(on request)

- Generic version
- Housing black or blue
- Company logo
- Client-specific adjustment
- Client-specific switching hysteresis

By usage of model AUF-2000 in hazardous areas, an intrinsically safe current power supply transmitter should be used and being rectified with the electrical data of the connected sensor.

Electrical connection

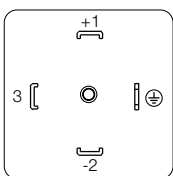

	AUF-1000 AUF-2000	AUF-1001	AUF-3000 AUF-4000
PIN 1	+VS / S+	+VS / S+	+VS
PIN 2	GND/S	GND/S	GND
PIN 3	-	Switch out	Signal

