

**Operating Instructions
for
Rotating Vane Flow Meter**

Model: DFT



1. Contents

1. Contents.....	2
2. Note	3
3. Instrument Inspection.....	3
4. Regulation Use	3
5. Operating Principle.....	4
6. Mechanical Connection.....	4
7. Electrical Connection	5
7.1 General.....	5
7.2 Evaluating Electronics (DFT-..0000, ..F400; ..F490, ..L403, ..L443)....	5
7.3 Evaluating Electronics DFT-....L442	5
7.4 MA-Electronics (DFT-...M..)	6
7.5 WM-Electronics (DFT-...W..).....	6
7.6 DFT-K/E/G (only with cable connection).....	7
8. Operation	8
8.1 MA Electronic (DFT-...M..)	8
8.2 WM Electronic (DFT-...W..).....	9
8.3 K/E/G-Electronic	10
9. Commissioning.....	11
10. Technical Information.....	11
11. Maintenance	14
12. Order Codes	15
13. Dimensions	16
14. Disposal	18
15. EU Declaration of Conformance	19
16. UK Declaration of Conformity.....	20

Manufactured and sold by:

Kobold Messring GmbH
Nordring 22-24
D-65719 Hofheim
Tel.: +49(0)6192-2990
Fax: +49(0)6192-23398
E-Mail: info.de@kobold.com
Internet: www.kobold.com

2. Note

Please read these operating instructions before unpacking and putting the unit into operation. Follow the instructions precisely as described herein.

The instruction manuals on our website www.kobold.com are always for currently manufactured version of our products. Due to technical changes, the instruction manuals available online may not always correspond to the product version you have purchased. If you need an instruction manual that corresponds to the purchased product version, you can request it from us free of charge by email (info.de@kobold.com) in PDF format, specifying the relevant invoice number and serial number. If you wish, the operating instructions can also be sent to you by post in paper form against an applicable postage fee.

The devices are only to be used, maintained and serviced by persons familiar with these operating instructions and in accordance with local regulations applying to Health & Safety and prevention of accidents.

When used in machines, the measuring unit should be used only when the machines fulfil the EC-machine guidelines.

as per PED 2014/68/EU

In acc. with Article 4 Paragraph (3), "Sound Engineering Practice", of the PED 2014/68/EU no CE mark.

3. Instrument Inspection

Instruments are inspected before shipping and sent out in perfect condition.

Should damage to a device be visible, we recommend a thorough inspection of the delivery packaging. In case of damage, please inform your parcel service / forwarding agent immediately, since they are responsible for damages during transit.

Scope of delivery:

The standard delivery includes:

- Rotating Vane Flow Meter model: DFT

4. Regulation Use

Any use of the Rotating Vane Flow Meter, model: DFT, which exceeds the manufacturer's specifications, may invalidate its warranty. Therefore, any resulting damage is not the responsibility of the manufacturer. The user assumes all risk for such usage.

5. Operating Principle

The established vane technology has proven itself a million times world wide for measuring and monitoring the flow of different media through piping. KOBOLD flow meters/monitors work with this proven principle and offer many benefits.

The heart of the new KOBOLD vane is an embedded ring magnet; it is hermetically sealed from the flow medium. It transfers, in a non-contacting manner, the rotary motion of the vane to a Hall sensor attached to the case (in order to save space). This converts the rotary motion to a frequency signal that is proportional to the flow rate. The downstream KOBOLD evaluating electronics can output this signal to a display, convert it to (0(4)-20 mA, 0-10 V) analogue signal, or count it. It may also be used to switch up to two limit contacts. The ready and control states of the limit value relay are indicated by LEDs.

The modular design of KOBOLD flow monitors and measuring instruments is a system that can be universally applied; it is reasonably priced; and requires minimum space when in service. Very precise measurement results can be achieved under tough operating conditions with the KOBOLD electronics. The system is assembled with the electronics and delivered ready for service. The electronics are adjusted and tuned for use with the sensor. When retrofitted for other measuring ranges, the system may be readjusted with a similar device at any time.

6. Mechanical Connection

Before installation

- Please ascertain whether the actual flow throughput matches the flow range of the instrument. The flow range may be obtained from the label.



Warning! If the measuring range is exceeded by more than 20%, bearing damage may occur.

- Remove all packing materials and transport retainers and ensure that no such materials remain in the device.
- Make sure that the maximum operating pressure and temperature of the device are not exceeded. (see section 10 Technical Information)
- Mount the flow indication tension-free into the pipe.
- Protect the measuring tube from external damage.
- Avoid pressure surges in the measuring tube, such as those arising from fast start up/shut off of flow or pulsating flow.
- The contact-version units may not be installed at a location within an inductive field.
- If possible, it should be checked after mechanical installation, to see if the connections between union fittings and pipes are properly sealed

7. Electrical Connection

7.1 General



Caution! Make sure that the voltage values of your system correspond with the voltage values of the measuring unit.

- Make sure that the supply wires are de-energized.
- Connect the power supply and the evaluation of the output signal to the pins of the plug described below.



Warning! Incorrect wiring of the connections in the coupling plug can lead to the electronics being destroyed.

7.2 Evaluating Electronics (DFT-..0000, ..F400; ..F490, ..L403, ..L443)

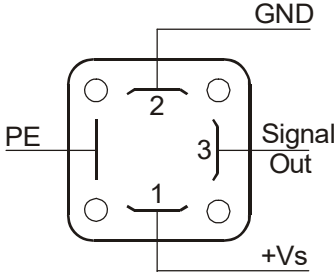

7.3 Evaluating Electronics DFT-....L442

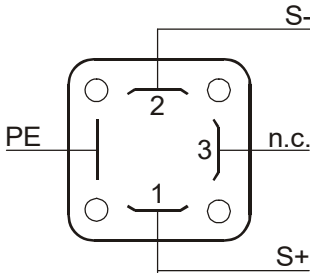

7.4 MA-Electronics (DFT-...M..)

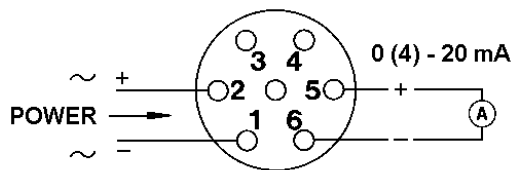

Cable connection

- Wire no. 1 = power supply (-)~
- Wire no. 2 = power supply (+)~
- Wire no. 3 = analogue output (+)

7.5 WM-Electronics (DFT-...W..)

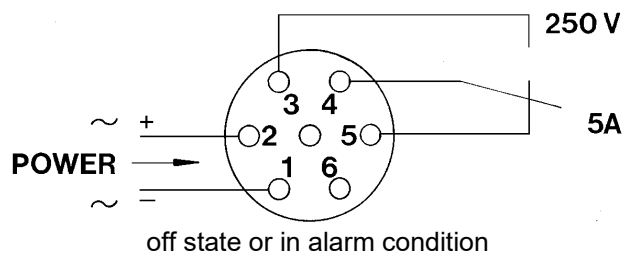

Cable connection

- Wire no: 1= power supply (-)
- Wire no. 2= power supply (+)
- Wire no. 3
- Wire no. 4
- Wire no. 5

**7.6 DFT-K/E/G
(only with cable connection)**

Wire number	DFT-K	DFT-E	DFT-G
1	+24 V _{DC}	+24 V _{DC}	+24 V _{DC}
2	GND	GND	GND
3	4-20 mA	4-20 mA	4-20 mA
4	GND	GND	GND
5	d.c. *)	d.c. *)	Ctrl 1 *)
6	d.c. *)	Reset TM *)	Ctrl 2 *)
7	relay S1 N/O	relay S1 N/O	relay S1 N/O
8	relay S1 COM	relay S1 COM	relay S1 COM
9	relay S2 N/O	relay S2 N/O	relay S2 N/O
10	relay S2 COM	relay S2 COM	relay S2 COM

8. Operation

8.1 MA Electronic (DFT-...M..)

The device is delivered ready for use. The electronics have been calibrated and fine tuned to the sensor. The calibrating screws (0(4)-20 mA) are behind an adhesive film and must not be adjusted by the customer. Adjustment by the customer means that a re-calibration is necessary (and this is chargeable). Unauthorised opening cancels the guarantee.

As soon as the external power supply to the device is switched on, a green light emitting diode indicates that it is ready for use.

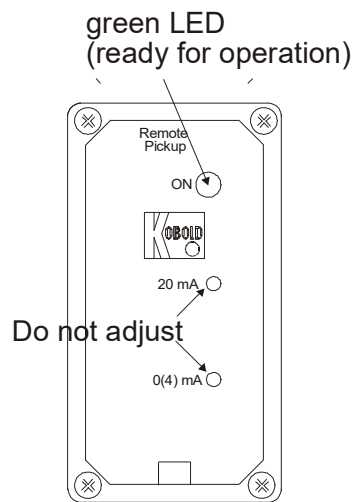

8.2 WM Electronic (DFT-...W..)

The device is delivered ready for use. The electronics have been calibrated and fine tuned to the sensor. The calibrating screws ("Zero" and "Range"), next to the scale button, must not be adjusted by the customer. Adjustment by the customer means that a re-calibration is necessary (and this is chargeable). Unauthorised opening cancels the guarantee.

As soon as the external power supply to the device is switched on, a green light emitting diode indicates that it is ready for use. The red "Alarm" Light emitting diode flashes.

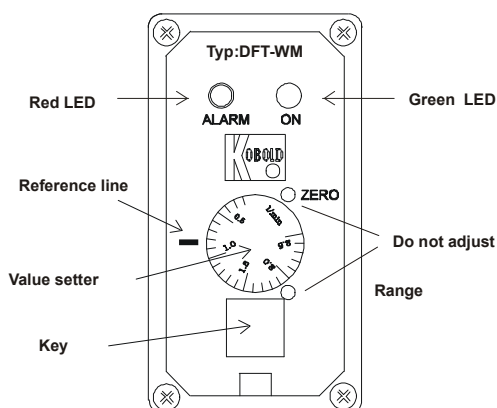

Attention! When the red light emitting diode is flashing the limit value relay is in alarm condition (see connection diagram).

The DF-WM has a relay output for monitoring the flow. The condition of the relay is indicated with a flashing red light emitting diode. The contact is in the form of a minimum contact, i.e. if the reading drops below the set value the limit value relay is in alarm condition (flashing red light emitting diode).



Attention! The limit value relay also goes into alarm condition in the event of a line break or power outage.

Setting the limit value

Loosen the 4 screws on the transparent electronics cover and remove it.

The limit value is set using the value setter.

Turn the value setter to the desired limit value on the scale to the reference line to the left of the scale on the front plate.

Calling up the current flow through reading

To measure the actual flow rate, it is first necessary to press the red key. This bypasses the limit value relay and puts it out of action. The flow through can be determined by simultaneously turning the value setter from the smallest to the greatest value until the red LED flashes, at which point the flowrate can be read from the scale on the value setter. After the flow through reading has been read the value setter is reset to the desired limit value and the button key is released.



Attention! After setting the limit value relay, or calling up the flow through, screw the transparent cover tightly back onto the electronics housing. Make sure the flat gasket is sitting correctly.

8.3 K/E/G-Electronic

Detailed information about the functions and operation, refer to the operating instructions "ZED-K", "ZED-ZL" and "ZED-ZL".

9. Commissioning

To avoid pressure surges, the flow medium should be slowly introduced into the instrument.



Warning! Pressure surges from solenoid valves, ball valves or similar devices may lead to breakage of the instrument (water hammer). In the operating condition it must be ensured that the instrument housing is continuously filled with the flow medium.

Warning! Large air bubbles in the instrument housing can lead to measuring errors or destruction of the bearings.

10. Technical Information

Sensor

Measuring accuracy:	2.5 % f. s. 5 % f. s. (DFT-...0000)
Medium temperature:	-20 to +80 °C
Ambient temperature:	-20 to +80 °C
Max. operating pressure:	5 bar (PTFE housing) 16 bar (brass housing)
Max. pressure loss:	see table
Protection type:	IP 65

Materials:

Housing/cover:	PTFE or brass
Vane:	PTFE
Axle:	Ceramics Al ₂ O ₃ or sapphire
Bearing:	PTFE
Gasket:	NBR (DFT-11..; DFT-16..) FEP-O-Seal with silicone (DFT-13..; DFT-18..)
Front- and back panel:	Aluminium, black anodized (DFT-13..; DFT-18.. only; not media-contacting)
Screwing:	stainless steel

Electronics

Frequency output (OEM)

Power supply:	5-24 V _{DC}
Power input:	approx. 5 mA
Signal amplitude high:	approx. power supply
Signal amplitude low:	= 0.2 V
Output loss: max.	2.5 mW
Electrical connection:	connector DIN 43 650
Pulse output:	NPN, open collector, max. 15 mA

Frequency output (option frequency divider)

Power supply:	24 V _{DC} ± 20 %
Power input:	40-50 mA
Signal amplitude high:	approx. power supply
Signal amplitude low:	= 0.2 V
Output loss:	max. 2.5 mW
Electrical connection:	connector DIN 43 650
Division factor (option):	0.25...2 factory set
Pulse output: PNP,	open collector, max. 20 mA

Analogue output (L electronics)

Power supply:	24 V _{DC} ± 20 %
Output:	0-20 mA or 4-20 mA, 3-wire or 2-wire (2-wire 4-20 mA only)
Max. load:	500 Ohm.
Electrical connection:	connector DIN 43 650

Analogue output (MA electronics)

Power supply:	24 V _{DC} +15% / -10 % 24/115/230 V _{AC} ± 20 %
Power input:	3.5 W max.
Output:	0(4)-20 mA or 0-10 V (floating, 24 V _{DC} non-isolated)
Max. load:	500 Ohm.
Electrical connection:	1.5 m cable connection or connector

Switching output (WM electronics)

Power supply:	24 V _{DC} +15% / -10 % 24/115/230 V _{AC} ± 20 %
Power input:	3.5 W max.
Output:	changeover contact, max. 250 V/5 A
Contact resistance:	< 100 m.
Electrical connection:	1.5 m cable connection or connector

“K” electronics with digital display, min/max. contact, analogue output

Display:	double-spaced display, illuminated flow value with selectable units and bargraph display
Power supply:	24 V _{DC} ±20 %
Current consumption:	approx. 100 mA
Electrical connection:	10 wire cable connection
Analogue output:	(0)4...20 mA selectable Load: 0...500 Ω or 0-10 V _{DC} , Load: >100 kΩ
Switching output:	2 relays, max. 30 V / 2 A
Control elements:	via 3 keys
Functions:	MIN/MAX memory, flow monitor, language settings, password protection

Counter-Electronics “E”

Display:	2 x 8-digit LCD module, illuminated, total, part and flow quantity; units of measurement selectable
Quantity meter:	8-digit
Power supply:	24 V _{DC} ±20 %
Current consumption:	approx. 100 mA
Electrical connection:	10-pole cable connection
Analogue output:	0(4)...20 mA selectable Load: 0...500 Ω or 0-10 V _{DC} , Load: >100 kΩ
Relay outputs:	2 relays, max. 30 V / 2 A
Control elements:	via 4 keys
Functions:	Reset, MIN/MAX-memory, flow monitor, monitoring of part and total quantities, language

Dosage-Electronics “G”

Display:	2 x 8-digit LCD module, illuminated dosage, total and flow quantity, units of measurement are selectable
Quantity meter:	8-digit
Dosage:	5-digit
Power supply:	24 V _{DC} ±20 %
Current consumption:	approx. 100 mA
Electrical connection:	10-pole cable connection
Analogue output:	0(4)...20 mA selectable Load: 0...500 Ω or 0...10 VDC, Load >100 kΩ
Relay outputs:	2 relays, max. 30 V / 2 A
Control elements:	via 4 keys
Function:	dosage (relay S2), start, stop, reset, fine dosage, correction quantity, flow monitor, total volume monitoring, language

11. Maintenance

In cases where the flow medium is uncontaminated, the DF-D instrument will remain maintenance-free. As the rotating vane contains magnets, any ferritic particles present in the medium can lead to problems. In order to avoid such problems, we recommend the installation of a magnet filter, e.g. magnet filter type MF-R.

Should cleaning of the instrument become necessary, the housing cover can be easily removed to provide access to the internals. After cleaning, the instrument can easily be reassembled. Any work on the electronics may only be undertaken by the supplier; otherwise, the guarantee will become invalid.

12. Order Codes

Order Details (Example: DFT-1101 G2 F400)

Measuring range [L/min]	Model				Connection female thread
	Brass housing ceramic axle	PTFE housing ceramic axle	Brass housing sapphire axle	PTFE housing sapphire axle	
0.2 - 2.0 0.5 - 7 1 - 16	DFT-1103.. DFT-1107.. DFT-1116..	DFT-1303.. DFT-1307.. DFT-1316..	DFT-1603.. DFT-1607.. DFT-1616..	DFT-1803.. DFT-1807.. DFT-1816..	..G2.. = G 1/4 ..G4.. = G 1/2 ..N2.. = 1/4 NPT ..N4.. = 1/2 NPT
2-36	DFT-1136..	DFT-1336..	DFT-1636..	DFT-1836..	..G4.. = G 1/2 ..G5.. = G 3/4 ..N4.. = 1/2 NPT ..N5.. = 3/4 NPT
3-60	DFT-1160..	DFT-1360..	DFT-1660..	DFT-1860..	..G5.. = G 3/4 ..N5.. = 3/4 NPT

Evaluating electronics		
OEM frequency output (OEM) ...0000 = NPN, connector DIN 43 650 Frequency output ...F400 = PNP, connector DIN 43 650 ...F490 = PNP, connector DIN 43 650, frequency divider 0.25...2 Analogue output ...L403 = connector DIN 43 650, 0 - 20 mA, 3-wire ...L443 = connector Din 43 650, 4 - 20 mA, 3-wire ...L442 = connector DIN 43 650, 4 - 20 mA, 2-wire		
MA electronics with analogue output		
Electronic type	Auxiliary power	Analogue output
..MK.. = 1.5 m cable connection ..MS.. = connector ..MG.. = connector and mating connector	..0.. = 230 V _{AC} ..1.. = 110 V _{AC} ..2.. = 24 V _{AC} ..3.. = 24 V _{DC}	..0 = 0 - 20 mA ..4 = 4 - 20 mA ..1 = 0 - 10 V
MA electronics with analogue output		
Electronic type	Auxiliary power	Analogue output
..WK.. = 1.5 m cable connection ..WS.. = connector ..WG.. = connector and mating connector	..0.. = 230 V _{AC} ..1.. = 110 V _{AC} ..2.. = 24 V _{AC} ..3.. = 24 V _{DC}	..X = without analogue output
K electronics (display, MIN/MAX-contact, analogue output)		
Electronic type	Auxiliary power	Analogue output
..KK.. = 1.5 m cable connection	..3.. = 24 V _{DC}	..0 = 0 - 20 mA ..4 = 4 - 20 mA ..1 = 0 - 10 V
Counter electronics / dosage electronics		
Elektronic-type	Electrical connection / power supply	Analogue output
E = counter electronics (2 x changer) G = dosage electronics (2 x changer)	3 = plug 2xM12/24 V _{DC} 1 = 1,5 m cable /24 V _{DC} 9 = x m cable /24 V _{DC}	4R = 0(4)-20 mA 1R = 0-10 V

13. Dimensions

Dimensions Brass Housing [mm]

DFT-...0000

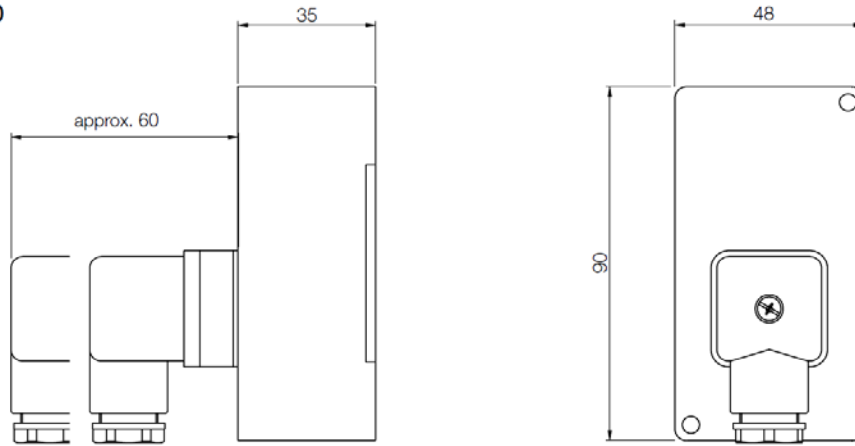

DFT-...F4... / DFT-...L4...

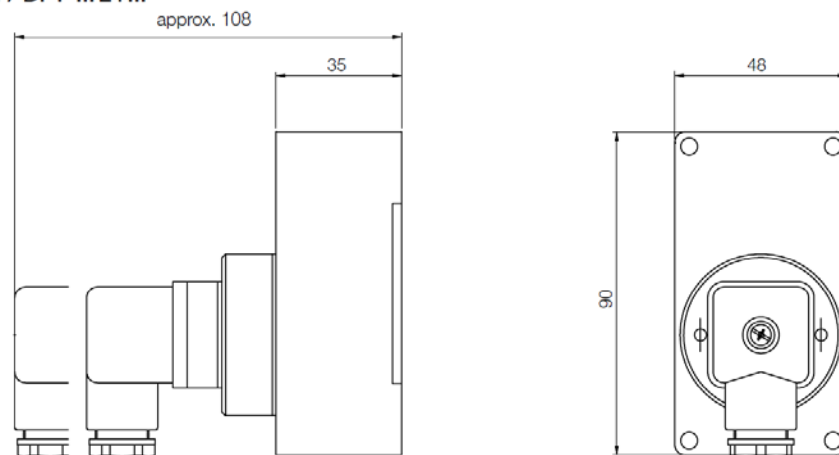

DFT with MA- / WM- / K- / E- / G- electronics

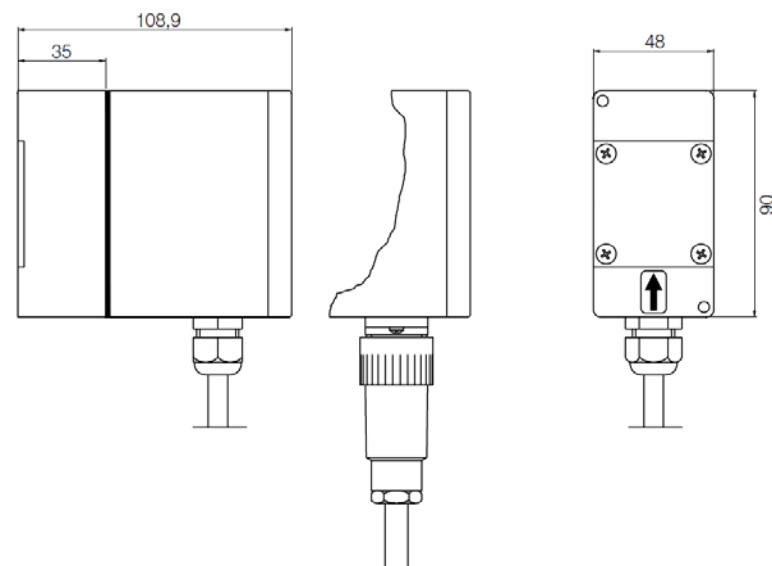

Dimensions PTFE Housing [mm]

DFT-...0000

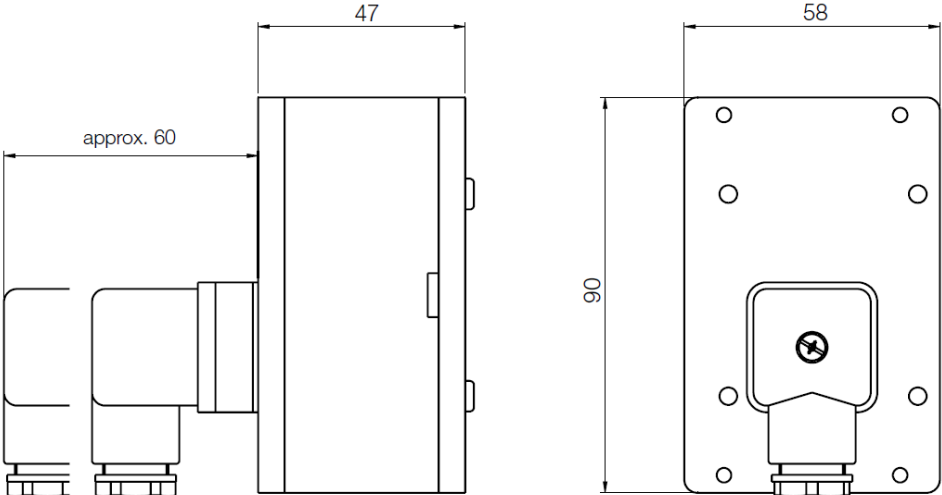

DFT-...F4... / DFT-...L4...

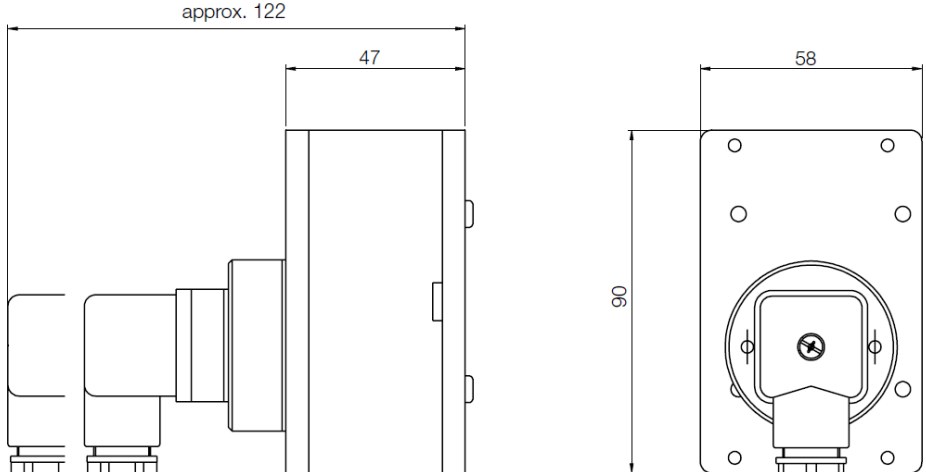

DFT with MA- / WM- / K- / E- / G- electronics

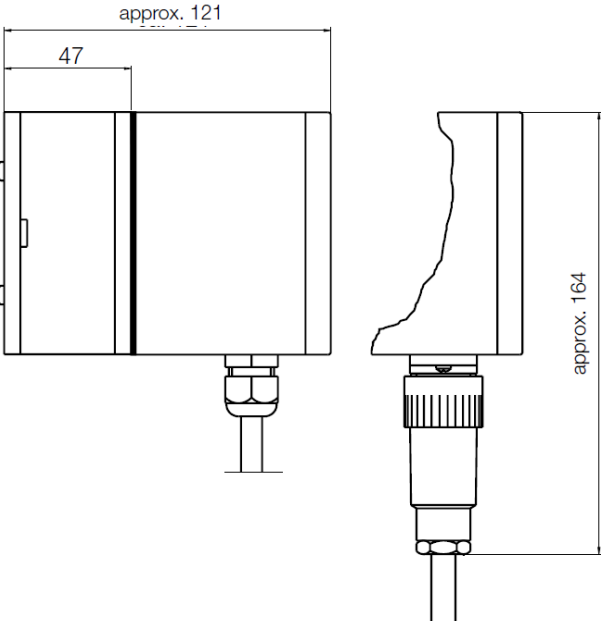

14. Disposal

Note!

- Avoid environmental damage caused by media-contaminated parts
- Dispose of the device and packaging in an environmentally friendly manner
- Comply with applicable national and international disposal regulations and environmental regulations.

Batteries

Batteries containing pollutants are marked with a sign consisting of a crossed-out garbage can and the chemical symbol (Cd, Hg, Li or Pb) of the heavy metal that is decisive for the classification as containing pollutants:

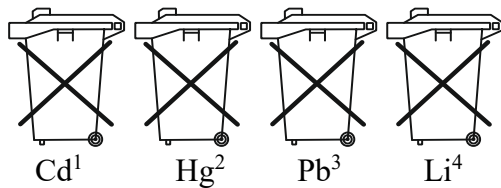

1. „Cd" stands for cadmium
2. „Hg" stands for mercury
3. „Pb" stands for lead
4. „Li" stands for lithium

Electrical and electronic equipment

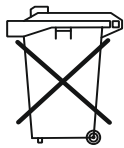

15. EU Declaration of Conformance

We, KOBOLD Messring GmbH, Hofheim-Ts, Germany, declare under our sole responsibility that the product:

Rotating Vane Flow Meter Model: DFT

to which this declaration relates is in conformity with the standards noted below:

EN 61000-6-4:2011

Electromagnetic compatibility (EMC) - Part 6-4: Generic standards - Emission standard for industrial environments

EN 61000-6-2:2006

Electromagnetic compatibility (EMC) - Part 6-2: Generic standards - Immunity for industrial environments

EN 61010-1:2011

Safety requirements for electrical equipment for measurement, control and laboratory use - Part 1: General requirements

EN 60529:2014

Degrees of protection provided by enclosures (IP Code)

EN IEC 63000:2018 Technical documentation for the assessment of electrical and electronic products with respect to the restriction of hazardous substances

Also, the following EC guidelines are fulfilled:

2014/30/EU

EMC Directive

2014/35/EU

Low Voltage Directive

2011/65/EU

RoHS

2015/863/EU

Delegated Directive (RoHS III)

Hofheim, 17 Dec. 2021

H. Volz
General Manager

M. Wenzel
Proxy Holder

16. UK Declaration of Conformity

We, KOBOLD Messring GmbH, Hofheim-Ts, Germany, declare under our sole responsibility that the product:

Rotating Vane Flow Meter Model: DFT

to which this declaration relates is in conformity with the standards noted below:

BS EN 61000-6-4:2007+A1:2011

Electromagnetic compatibility (EMC). Generic standards. Emission standard for industrial environments

BS EN 61000-6-2:2005

Electromagnetic compatibility (EMC). Generic standards. Immunity for industrial environments

BS EN 61010-1:2010

Safety requirements for electrical equipment for measurement, control, and laboratory use. General requirements

BS EN 60529:1992+A2:2013

Degrees of protection provided by enclosures (IP-Code)

BS EN IEC 63000:2018

Technical documentation for the assessment of electrical and electronic products with respect to the restriction of hazardous substances.

Also, the following UK guidelines are fulfilled:

S.I. 2016/1091

Electromagnetic Compatibility Regulations 2016

S.I. 2016/1101

Electrical Equipment (Safety) Regulations 2016

S.I. 2012/3032

The Restriction of the Use of Certain Hazardous Substances in Electrical and Electronic Equipment Regulations 2012

Hofheim, 17 Dec. 2021



H. Volz
General Manager



M. Wenzel
Proxy Holder